

# MODEL EJ-10

## Multi-Input Adapter Box



**Solve Your Sound  
Connection Problems The Easy Way...**

# **The EJ-10**

## **Table of Contents**

### **Controls and Functions**

#### **Basic Information**

Read this section for basic information on what the EJ-10 is: what it includes, how it works, and what you need to use it.

#### **Using the EJ-10 with Audio Equipment**

Read this section for step-by-step instructions for using the EJ-10 in some common situations.

- Using the EJ-10 with audio devices with AUX-type connections
- Using the EJ-10 with audio devices with loudspeaker connections
- Troubleshooting

#### **Using the EJ-10 with Telephones**

Read this section for complete information and instructions for using the EJ-10 with telephones.

- Listen to a telephone conversation over your sound system
- Play an audio device into the telephone line
- Play an audio device into the telephone line to be heard on a sound system in another location (requires two EJ-10's)
- Allow the proceedings at one location to be heard at another over telephone lines (requires two EJ-10's)

#### **Technical Information**

Read this section for details about the Emtech Model EJ-10 Multi-Input Adapter Box's technical specifications.

#### **Warranty**

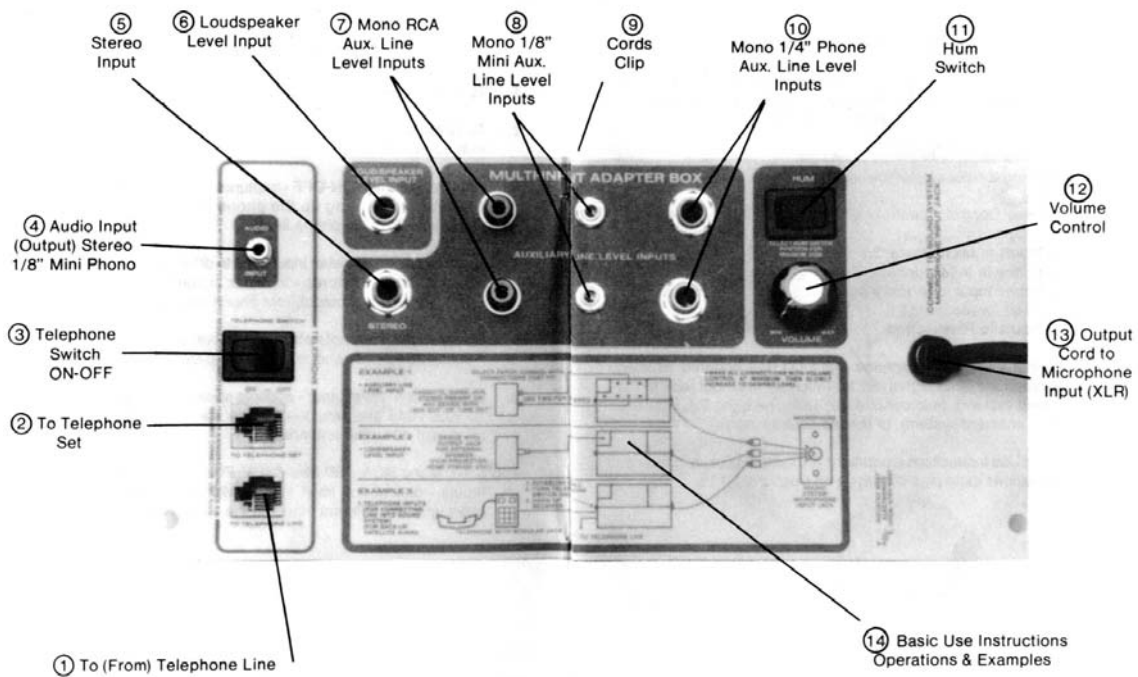

## Controls & Functions

1. To (From) Telephone Line – allows any telephone line input.
2. To Telephone Set – allows parallel telephone set connection with EJ-10 – to establish call.

3. Telephone Switch ON-OFF – captures and holds telephone line allowing you to hang up the phone without losing the call – connects EJ-10 to phone line.
4. Audio Input – lowest lever input used to drive phone line (8 Vp-p) minimum buffered stereo – for weak signal to microphone out – also highest level output from phone line input.
5. Stereo Input – accepts stereo line level audio signal input – 1 volt RMS to microphone – or 25 Vp-p signal to phone line.
6. Loudspeaker Level Input – accepts speaker level signals up to 10 volts RMS and provides a power load 10 ohms – 10 watts for lowest distortion and noise.
- 7, 8 & 10. Mono RCA, 1/8” Mini & 1/4” Phone Auxiliary Line Level Inputs – accept line level 1 volt RMS input – buffered inputs allow up to six different inputs at the same time.
9. Cords Clip – patch cords are clipped to the EJ-10’s box so they won’t get lost.  
  
Clip can be removed to add or subtract patch cords.
11. Hum Switch – connects the shield ground from inputs to output allowing a selection for lowest hum pick up.
12. Volume Control – controls signal volume in any of 4 signal directions:
  - a) Inputs to Microphone Out
  - b) Phone In to Microphone Out
  - c) Phone Input to “Audio Input (Output) No. 4” connector (used for recording)
  - d) Inputs to Phone Out
13. Output Cord to Microphone Input (XLR) – buffered isolated microphone level  
  
signal out to: microphone input jack of the sound system, microphone wall jack, existing P.A., sound reinforcement system, or house sound system.
14. Basic Use Instructions Operations & Examples – quick reference operations  
Examples displayed on front of EJ-10’s.

## **The EJ-10 Basic Information**

The EJ-10 is a multi-input adapter box that allows you to use one or more pieces of audio/visual equipment with the speakers and volume of an existing public address (P.A.) or sound system. Several audio devices can be used simultaneously. The EJ-10 provides everything you need to simply connect tape recorders (of all types), record players, movie projectors, video cassette recorders, telephones, or electronic instruments (such as guitars or keyboards) to the microphone connection of an existing sound system.

Even though these audio devices use different plugs and strengths of signal, with the EJ-10 and its basic set of cables, these usually incompatible audio devices can work together. The EJ-10 provides the necessary matching and isolation to protect the existing public address system while providing a high quality audio interface to the system.

The EJ-10 has its own volume control which allows you to balance the signal of the incoming sound to the needs of your sound system. When more than one audio device is connected through the EJ-10, the EJ-10 serves as a master volume control. The EJ-10 uses the power from the signal itself; this means it doesn't need batteries or a power cord.

The cords attached to the back of the EJ-10 are some of the most useful kinds of cables for connecting your equipment to the EJ-10. These cables are clipped to the EJ-10's box so they won't get lost. If you find you frequently need another type of cable (as when using two audio devices which require identical cables), you can easily add it to the clip. Use a Phillips screwdriver to remove the clip to add more cords.

- Mini (1/8") to Standard (1/4") Stereo Phone Plugs
- Standard (1/4") to Standard (1/4") Phone Plugs
- Paired RCA to Mini (1/8") Phone Plugs
- Telephone Modular to Modular Plugs

The EJ-10 is the finest multi-interconnect system available. The EJ-10 does not compromise the quality of sound of the equipment it is used with; it expands the capabilities and range or use of whatever equipment you have. The EJ-10's straight-forward, efficient design ensures that you will enjoy many years of trouble-free use.

## **Using the EJ-10 with Audio Equipment**

### **Line Level Audio Devices**

Audio device Output labeled: LINE OUT, AUXILIARY, AUX OUT, EARPHONES, EAR, EXT. SP., PHONO, etc.

This section explains how to use the EJ-10 to properly connect the following audio devices to a microphone input jack (connector) of a sound system. Use this procedure with the following:

- Compact Disc Players
- Cassette Players
- AM/FM Stereo Cassette Players
- Tape Decks
- VCR's
- Radios
- Dictaphones
- Reel-to-Reel Tape Decks
- Stereo Receivers
- Record Players
- Musical Instruments (such as electric guitars and electronic keyboards)\*
- Or other equipment with the AUX-type output

NOTE: More than one audio device can be connected to the EJ-10 at the same time. In this case, the EJ-10's volume control serves as master volume control for all audio devices.

\* Electronic instruments will only work if they contain a preamplifier (pre-amp). If you are unsure whether the instrument has a pre-amp or not, you will not harm either the instrument or the EJ-10 by simply attempting to connect it as described below.

#### To Get Ready:

1. Take audio device and EJ-10 to the most convenient microphone connector of the sound system. NOTE: You need not attempt to remove the EJ-10 from its case; it is permanently attached to prevent loss or damage to the EJ-10 and its cables. If you cannot place the audio device near a microphone connector you will need a microphone extension cord long enough to reach from the EJ-10 to microphone connector. If you need it, plug the extension cord into the microphone connector and carefully place the cord so that the free end is within easy reach of the audio device and the EJ-10.
2. Turn the volume control knob of the EJ-10 down to minimum volume (MIN).
3. Plug in the audio device's power cord (use a properly rated extension cord if necessary).
4. Turn on the sound system and set its microphone volume control to a moderate or mid-way position.

#### To Make Connections:

5. Locate the output connector (jack) on the audio device. It may be labeled LINE OUT, AUXILIARY, AUX OUT, EARPHONES, EAR, EXT. SP., PHONO, etc. If the audio device is stereo, there may be two connectors: one for each channel.

NOTE: The EJ-10 mixes the stereo signals and sends a balanced, mono signal to the sound system. Some audio devices have AUX or MIC *inputs*, be sure to use *output* connectors.

6. Select the cord from the set on the back of the EJ-10 that mates with the output connector(s) you just located on the audio device. Plug the patch cord(s) into the audio device. Choose whichever end of the patch cord matches the audio device's output connector; the other end will mate with one of the inputs on the EJ-10. If need be, you may use only half of the paired cable.

NOTE: If your audio device has a single outlet stereo jack, use either the yellow Mini (1/8") to Standard (1/4") or the black Standard (1/4") to Standard Stereo cord. For audio devices with mini (1/8") jacks, plug the mini end of the yellow cord into the audio device. For audio devices with standard (1/4") jacks, plug either end of the standard cord into the audio device.

7. Check that the volume control on the EJ-10 is turned to MIN, then plug the other end of the patch cord (the cords are color coded) into the matching jack (or jacks for paired stereo cords) on the EJ-10. Choose from the seven jacks on the center top of the EJ-10 labeled AUXILIARY LINE LEVEL INPUTS and STEREO. If you used half of the paired cable, be sure to use the same color plug at both ends.

NOTE: If you used either the yellow or black single-connection stereo cord, be sure to use the STEREO jack on the EJ-10. Although standard plugs will fit into the standard jacks on the right of the EJ-10, use the STEREO jack for making single connector stereo connections.

8. Plug the XLR microphone connector (the connector on the thick black cord that comes out of the right side of the EJ-10) into the microphone input jack of the sound system (or into the microphone extension cord if you are using one).
9. Turn on the power to the audio device and turn its volume up partway (you should not hear anything yet).
10. Turn the EJ-10's volume control up to the desired level (with the audio device operating, you should be able to hear it now). If you have more than one audio device connected, use the audio devices' own volume controls to set the balance among them; the EJ-10 serves as the master volume control.
11. Try switching the EJ-10's HUM switch (on the upper right corner of the EJ-10) back and forth. Set it in the position that produces the least amount of hum.

## **Speaker Level Audio Devices**

### Device Output labeled: SPEAKER OUT

This section explains how to use the EJ-10 to connect the following audio devices to a microphone input jack (connector) of a sound system. Use this procedure with the following:

- 16 mm Film Projectors
- Super 8 and 8 mm Film Projectors (those with sound)
- Power Amplifiers
- Home Stereos
- Or other equipment with a SPEAKER OUT-type output

NOTE: More than one audio device can be connected to the EJ-10 at the same time. In this case, the EJ-10's volume control serves as master volume control for all audio devices.

### To Get Ready:

1. Take audio device and EJ-10 to the most convenient microphone connector of the sound system. If you cannot place the audio device near a microphone connector you will need a microphone extension cord long enough to reach from the EJ-10 to microphone connector. If you need it, plug the extension cord into the microphone connector and carefully place the cord so that the free end is within easy reach of the audio device and the EJ-10.
2. Turn the volume control knob of the EJ-10 down to minimum volume (MIN).
3. Plug in the audio device's power cord (use a properly rated extension cord if necessary).
4. Turn on the sound system and set its microphone volume to a moderate or mid-way position.

### To Make Connections:

5. Locate the output connector (jack) on the audio device. It may be labeled SPEAKER or SPEAKER OUT.
6. Select the black 1/4" Standard to Standard phone plug patch cord from the set on the back of the EJ-10. Plug one end into the audio device.
7. Check that the volume control on the EJ-10 is turned to MIN, then plug the other end of the patch cord into the jack on the EJ-10 labeled LOUDSPEAKER LEVEL



INPUT. (To prevent distortion, the EJ-10's loudspeaker connector provides a 10 ohm, 20 watt resistive load to the audio device).

8. Plug the XLR microphone connector (the connector on the thick black cord that comes out of the right side of the EJ-10) into the microphone input jack of the sound system.
9. Turn on the power to the audio device and turn the volume up partway (you should not hear anything yet).
10. Turn the EJ-10's volume control up to the desired level (with the audio device operating, you should be able to hear it now). If you have more than one audio device connected, use the audio devices' own volume controls to set the balance among them; the EJ-10 serves as the master volume control.
11. Try switching the EJ-10's HUM switch (on the upper right corner of the EJ-10) back and forth. Set it in the position that produces the least amount of hum.



Playing audio from boombox into your sound system.

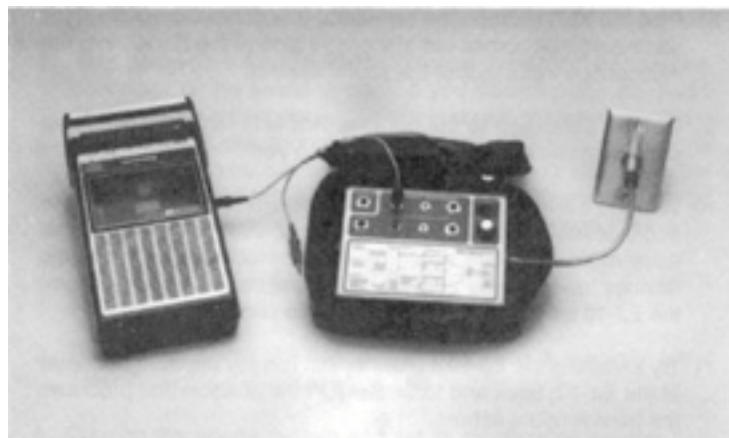

Playing audio from cassette player into your sound system.

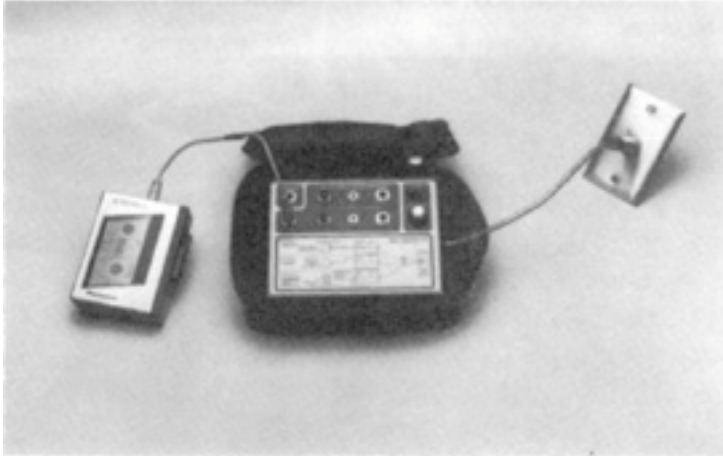

Playing audio from a portable cassette player into your sound system.

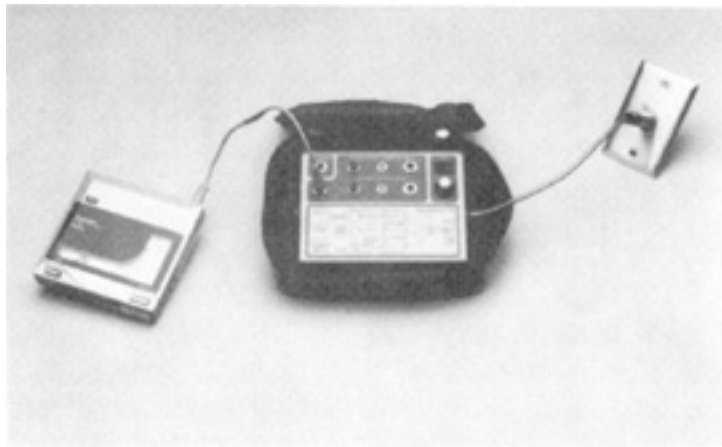

Playing audio from a CD player into your sound system.

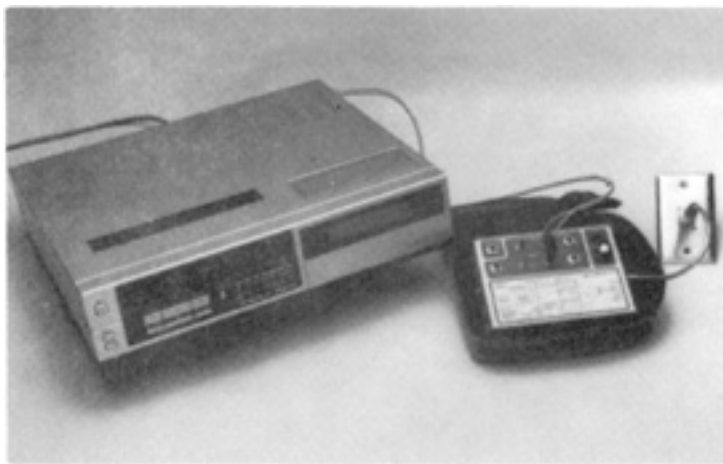

Playing audio from a VCR into your sound system.

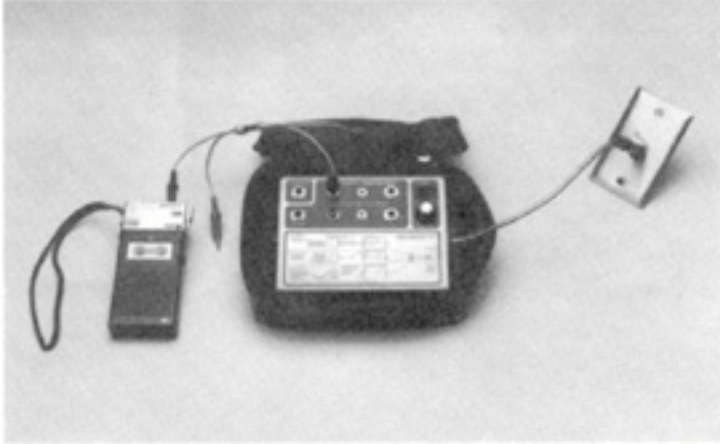

Playing audio from miniature voice recorder into your sound system.



Playing audio from a reel to reel tape recorder into your sound system.

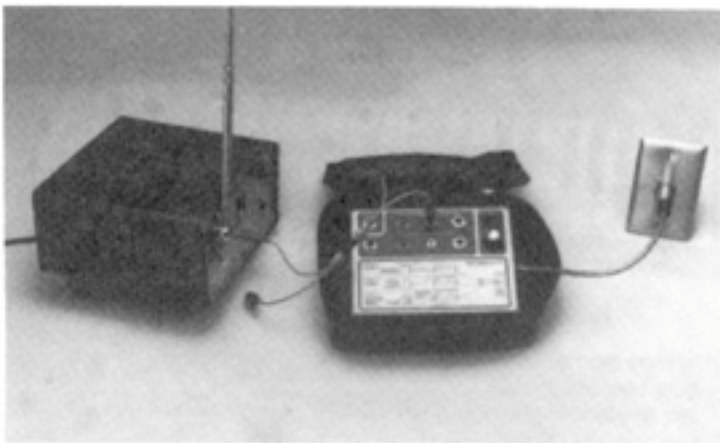

Playing an RF signal into your sound system.



Playing audio from a camcorder into your sound system.



Playing an electronic keyboard into your sound system.



Playing a guitar into your sound system.

## Troubleshooting

### All Audio Devices (Auxiliary Line Level or Loudspeaker)

#### Symptom

#### Corrective Procedure

#### Hum-background noise

Move HUM switch to the other position. Choose the position that produces the least hum.

#### No sound

#### Connection Problems

Be sure that you are using both ends of the same patch cord. Cord *and* plug colors must match. In particular, if you used half of the paired RCA/Mini phone plug cable, be sure you used the same color plug on both ends.

Some audio devices may have AUX level *inputs*; be sure that the patch cords are plugged into the OUTPUT jacks on the audio device.

Check that the plugs fit into the outlets completely and firmly. (The plugs with four thin metal “petals” around a central shaft must be used with outlets that have smooth collars that stick out from the connector).

The cord itself may have been damaged. Try a different cord if one is available.

#### No sound

#### Equipment and Sound System Problems

Check that the audio device itself is working. If it isn't getting power, the power outlet it is plugged into may be defective or turned off.

Check that the sound system is turned on (there is usually a power light to indicate that the unit is operating).

Check that the volume controls on both the audio device and the sound system are turned up to moderate levels. Try turning up the EJ-10's volume control.

If there is still no sound, disconnect the EJ-10 from the sound system's microphone input jack. Plug a microphone into the sound system and go through the following steps to test the sound system:

1. Check that the sound system amplifier is on.
2. Check that the microphone volume control knob is on and set to a moderate level.
3. Speak into the microphone to test the sound system.

At this point, the microphone should be working. If it isn't, the sound system itself is not working as needed for proper functioning with the EJ-10. You will need someone to check and perhaps repair the sound system.

If the microphone is working, continue with the following steps:

4. Disconnect the microphone and reconnect the EJ-10 to the microphone input jack.
5. Check that the audio device is turned on with its volume turned up to a moderate level.
6. Turn up the volume on the EJ-10.

If there is still no sound, verify the connections between the audio device and the EJ-10 if you have not already done so.

The cord itself may have been damaged. Try a different cord if one is available.

If you have tested the sound system and verified connections, there is a problem with either the audio device itself or the EJ-10. They will need to be checked and possibly repaired.

**Incomplete Stereo Sound** Check to see if the audio device has two audio line outputs.

**(Only one channel)** You must connect both to get both stereo channels.

If the audio device has a single *mini* (1/8") stereo outlet, be sure to use the yellow patch cord *and* plug the standard (1/4") end into the jack marked STEREO on the EJ-10.

If the audio device has a single *standard* (1/4") stereo outlet, be sure to use the black patch cord *and* plug the other end into the jack marked STEREO on the EJ-10.

### **Using the EJ-10 with Telephones**

In addition to allowing connection of many different kinds of audio devices to a sound system, the EJ-10 also has the ability to receive and send voice or music over telephone lines. The EJ-10 is accepted and approved for use with standard telephone lines. (For information about the FCC registration and telephone connection specifications, see the Technical Information section of this manual.)

### **Practical Telephone Applications**

The EJ-10 may be used to connect incoming or outgoing signals to the telephone lines. Some applications require an EJ-10 at both ends of the telephone line.

- Listen to a telephone conversation over your sound system
- Play an audio device into the telephone line
- Play an audio device into the telephone line to be heard on a sound system in another location (requires two EJ-10's).
- Allow the proceedings at one location to be heard at another over telephone lines (requires two EJ-10's).

### **Listen to a Telephone Conversation over your Sound System**

To connect an incoming telephone signal to your sound system, follow these steps:

1. Plug the telephone patch cord provided with the EJ-10 into the TO TELEPHONE LINE connector on the left side of the EJ-10.
2. Unplug the telephone's own cord from the wall jack. Plug the other end of the telephone patch cord into the wall jack. Plug the telephone's cord into the TO TELEPHONE SET connector on the EJ-10.
3. Set the volume control knob on the EJ-10 to minimum level (MIN). Turn on the sound system and set its volume to a moderate or mid-way position. Plug the XLR microphone connector (the connector on the thick black cord that comes out of the right side of the EJ-10) into the microphone input jack of the sound system. Set the microphone level of the sound system to a moderate or mid-way position.
4. Place the telephone call by dialing the number as you normally would. You can also receive a telephone call in the normal way.
5. When the connection is established, turn the EJ-10's TELEPHONE SWITCH to ON (this allows you to hang up the phone without losing the call).
6. Slowly increase the volume to the desired level using the knob on the EJ-10 while listening on the telephone handset.

7. Try switching the EJ-10's HUM switch (on the upper right corner of the EJ-10) back and forth. Set it in the position that produces the least amount of hum.
8. Hang up telephone receiver to prevent feedback from the sound system.
9. It is possible for both parties to speak over the sound system.  
**Caution:** the sound levels need to be carefully set to prevent feedback.

### **Play an Audio Device into the Telephone Line**

To connect an audio device such as a cassette player, record player, compact disc player, and so on to a telephone line, follow these steps:

1. Plug the telephone patch cord provided with the EJ-10 into the TO TELEPHONE LINE connector on the left side of the EJ-10.
2. Unplug the telephone's own cord from the wall jack. Plug the other end of the telephone patch cord into the wall jack. Plug the telephone's cord into the TO TELEPHONE SET connector on the EJ-10.
3. Select the correct patch cord and attach the output of the audio device to the EJ-10 through the Telephone Audio Input jack on the left side of the EJ-10. Note: use of the Telephone Audio Input jack is preferred in this application; however, this arrangement may not be possible with the cables provided. For example, if the audio device had a mini stereo output (1/8") you must have your own mini-to-mini stereo cable.
4. Set the volume control knob on the EJ-10 to minimum level (MIN).
5. Place the telephone call by dialing the number as you normally would. You can also receive a telephone call in the normal way.
6. When the connection is established, turn the EJ-10's TELEPHONE SWITCH to ON (this allows you to hang up the phone without losing the call).
7. Turn on the audio device and set its volume to a moderate or mid-way position.
8. Using the knob on the EJ-10, slowly increase the volume to the desired level while listening on the telephone handset. If you set the level too high, it will sound distorted on the handset.

### **Play an Audio Device into the Telephone Line to be Heard on a Sound System in Another Location (requires two EJ-10's)**

To play an audio device into the telephone line to be heard on a sound system in another location, you must have an EJ-10 at both locations. Follow this procedure:



1. At the primary location, connect the audio device to the EJ-10 as described above (Play an Audio Device into the Telephone Line).
2. Call the remote location
3. At the remote location, follow the procedure for playing an incoming signal over your sound system as described above (Listen to a Telephone Conversation over Your Sound System).

**Allow the Proceedings at one Location to be Heard at Another over Telephone Lines (requires two EJ-10's)**

To allow the proceedings at one location to be heard at another auditorium over a telephone line, you must have an EJ-10 at both locations. Follow this procedure:

1. At the primary location, connect the sound system's OUTPUT connector to the EJ-10 as described above. (See Playing an Audio Device into the Telephone Line. NOTE: A stronger or speaker level signal may be connected to the EJ-10 through the LOUDSPEAKER LEVEL INPUT or the appropriate AUXILIARY LINE LEVEL INPUT on top of the EJ-10.)
2. Call the remote location.
3. At the remote location, follow the procedure for playing an incoming signal over your sound system as described above (Listen to the Telephone Conversation over Your Sound System).



Listen to a phone conversation over your sound system.



Play an audio device into the telephone line.

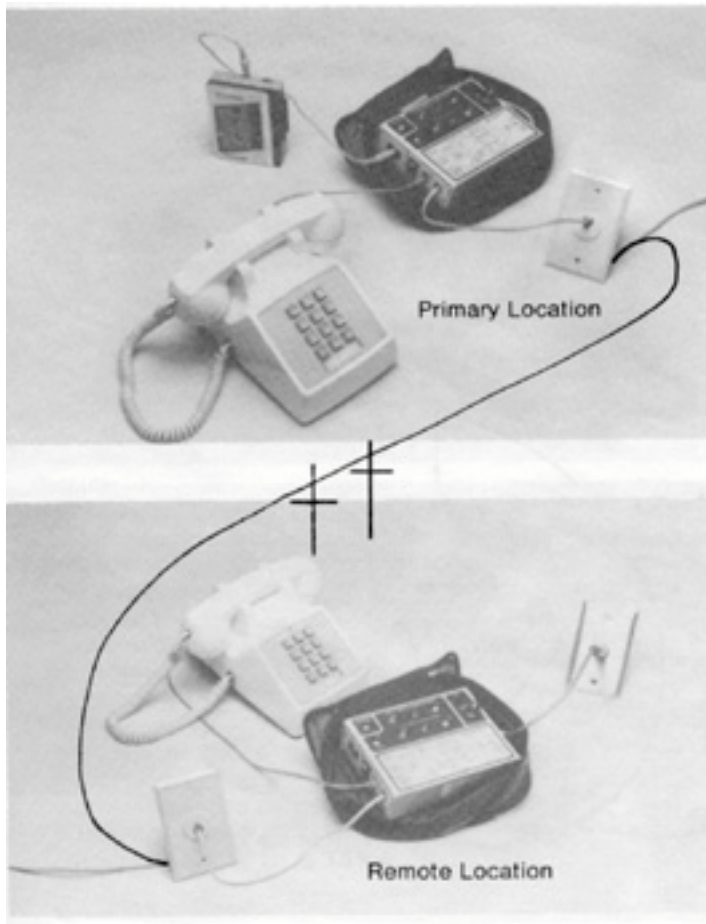

Play an audio device into the telephone line to be heard on a sound system in another location (requires two EJ-10's).

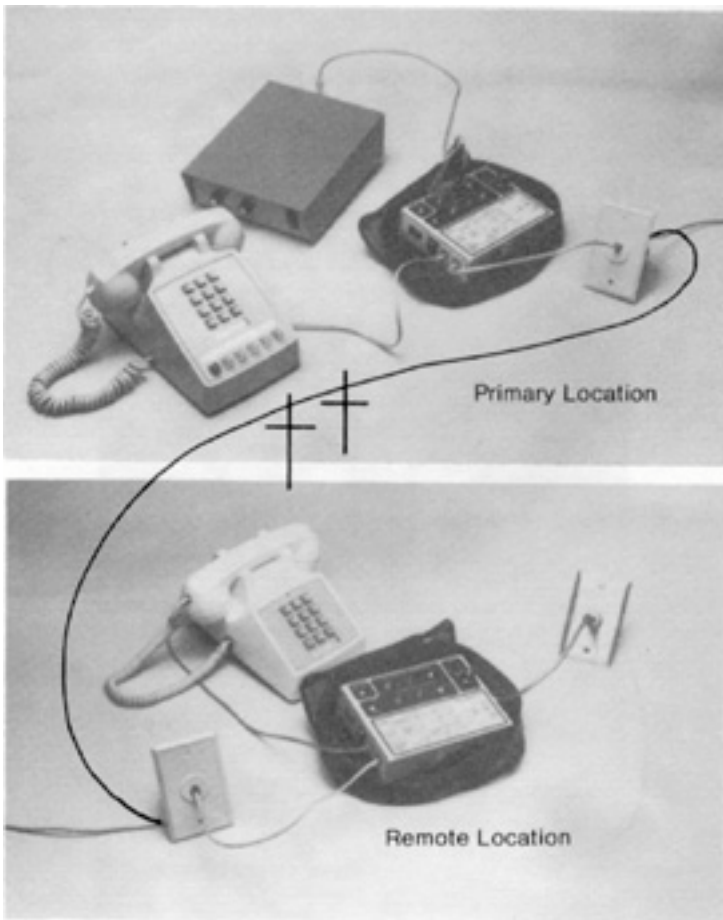

Allow the proceedings at one location to be heard at another location over the telephone line (requires two EJ-10's).

## Technical Information

### Model EJ-10 Multi-Input Adapter Box

#### Specifications

##### Inputs:

Unbalanced Line

Stereo phone, phone, mini phone, & "RCA" phono

Speaker Level

1/4-inch phone plug

Telephone Line

Modular jack (FCC Regulation No. E8P5IE-71393-VP-N;  
Ringer Equivalence: 0.38)

##### Outputs:

Transformer balanced low-impedance (100 ohms) adjustable mic level output on  
3-foot cable with make XLR type plug.

Telephone modular jack to connect standard telephone for initiating calls.

##### Attenuation:

Low levels: +18 dB to + Infinity

Line levels: +41 dB to + Infinity

Speaker level: +55 dB to + Infinity

Telephone: +30 dB to + Infinity

##### Frequency Response (nominal):

Speaker & line: 10 Hz to 18 kHz

Telephone line: 60 Hz to 3.5 kHz

##### Supplied Interconnect Cables:

- 1/4-inch stereo phone plug to 1/8-inch stereo mini phone plug
- 1/4-inch stereo phone plug (both ends)
- Paired RCA type to paired 1/8-inch mini phone plugs
- Telephone modular plug (both ends).

##### Size:

3 in. H x 9 in. L x 6.5 in. W

##### Weight:

2 lbs. (0.9 kg)

##### Package:

All metal case mounted inside a black fabric protective zippered case with carrying handle. Supplied interconnect cables attached to clip on back of metal case (cables enclosed by protective case).

## Architects' and Engineers' Specifications

The general purpose adapter box shall accept mono or stereo line and speaker level inputs and allow seized connection to the local telephone system and convert them to transformer balanced mic level output. The unit must have an adjustable output control, a hum removal switch, and a telephone line seize switch. All system interconnect cables must be attached to the unit and a padded zippered carrying case must be provided for protection and transporting. Basic instructions and a block diagram must be imprinted on the front panel and a complete operations manual must be stored in the carrying case. The size must be 3 in. (7.6 cm) H x 9 in. (22.9 cm) L x 6.5 in. (16.5 cm) W and its weight shall be 2 lbs. (0.9 kg).

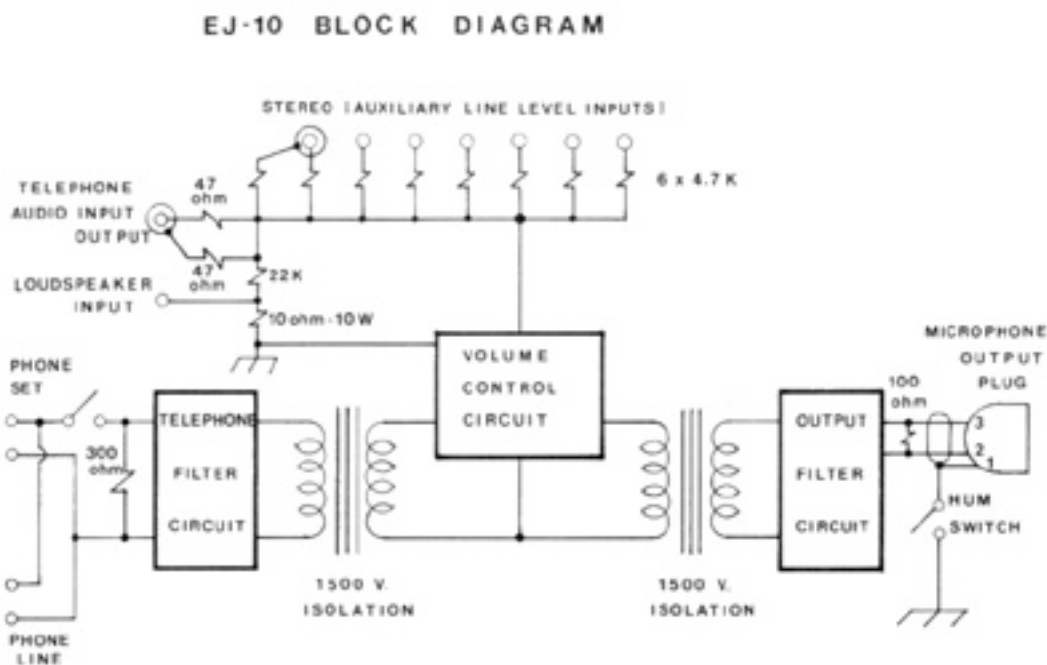

## **Limited Warranty**

The Model EJ-10 is guaranteed for two years from date of original purchase against malfunction due to defects in workmanship and materials. If such malfunction occurs, unit will be repaired or replaced (at manufacturer's option) without charge for materials or labor if delivered prepaid to the factory. Unit will be returned prepaid.

This warranty does not extend to finish, appearance, malfunction due to abuse, or operation under other than specified conditions, nor does it extend to incidental or consequential damages. Repair by anyone other than Emtech voids this warranty. Any other warranty, expressed or implied is expressly excluded. You may also have other rights which vary from state to state.

**EMTECH ELECTRONICS, INC.**  
**1126 NORTH 1200 WEST**  
**OREM, UTAH 84057**  
**(866) 200-2878**  
**(801) 426-8333**  
**FAX (801) 426-8334**  
**[www.emtechelectronics.com](http://www.emtechelectronics.com)**